

# SPINNING REEL

# ELT4500/6500/8000

\*Please order by parts number, not key number.

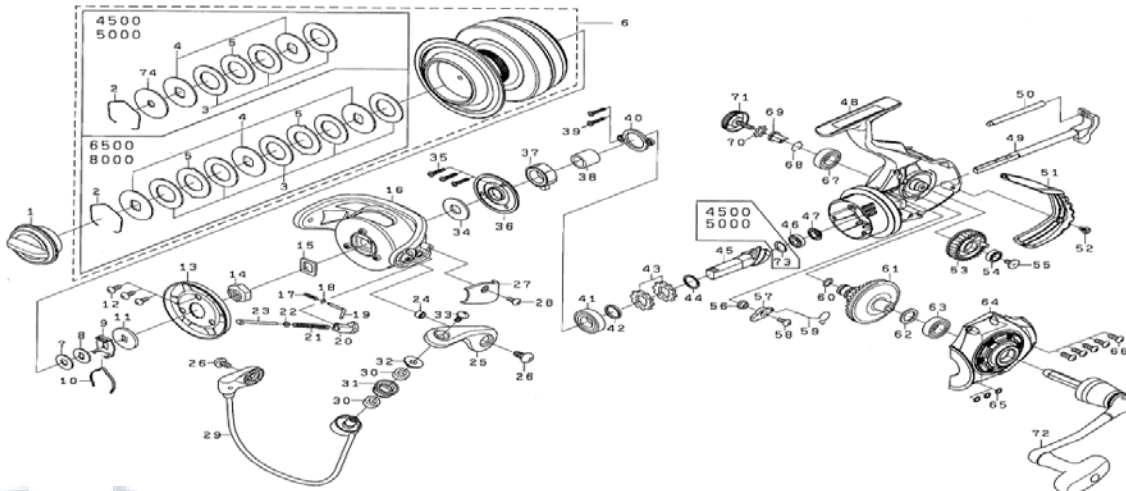

Key No	Part No	Description
1	J79-4101	DRAG KNOB ASSY
2	F88-4001	DRAG RING
3	F69-1001	DRAG WASHER
4	H17-5101	DRAG DISC WASHER(A)
5	G70-0701	DRAG LIP WASHER
6	J79-3901	SPOOL ASSY ( 2-5 )
7	F05-0104	SPOOL WASHER (A)
8	F05-0002	SPOOL WASHER (B)
9	H30-9501	CLICK HOLDER
10	B74-7701	CLICK REAF SPRING
11	F04-9901	MAIN SHAFT WASHER
12	G27-0801	ROTOR COVER SCREW
13	J32-2501	ROTOR COVER
14	J32-2401	ROTOR NUT
15	G39-2202	ROTOR NUT PLATE
16	J32-1601	ROTOR
17	H50-3401	ROTOR BRAKE SPRING
18	G68-5401	ROTOR BRAKE WASHER
19	H50-3301	ROTOR BRAKE SHAFT
20	J32-2001	ARM LEVER SPRING COLLAR
21	J32-1901	ARM LEVER SPRING
22	J32-1801	ARM LEVER SHAFT WASHER
23	J32-1701	ARM LEVER SHAFT
24	H94-5501	ARM LEVER SCREW COLLAR
25	J30-9703	ARM LEVER
26	G45-5601	ARM LEVER SCREW
27	J32-2104	ARM LEVER SPRING COVER
29	J32-3301	BAIL ASSY
30	J41-6001	ROLLER COLLAR (A)
31	H24-6103	LINE ROLLER
32	J31-0401	ROLLER COLLAR (B)
33	F60-8901	ROLLER SCREW
34	J30-9301	ONEWAY CLUTCH PLATE WASHER
35	J00-1601	ONEWAY CLUTCH PLATE SCREW
36	J32-3901	ONEWAY CLUTCH PLATE
37	J30-9101	ONEWAY CLUTCH
38	J30-9002	CLUTCH RING
39	J00-1602	PINION BEARING PLATE SCREW
40	J30-8401	PINION BEARING PLATE
41	G42-6301	PINION BALL BEARING (A)
42	G61-3404	PINION BEARING WASHER (A)
43	E26-2701	RATCHET
45+61	202-3256	PINION GEAR + DRIVE GEAR UNIT
46	G52-2706	PINION BALL BEARING (B)
47	J32-0901	PINION BALL BEARING (B) COLLAR
48	J79-3401	BDY ASSY
49	J32-0501	MAIN SHAFT
50	J32-0801	OSCILLATING POST (A)
51	J32-1506	REAR CAP
52	J00-1801	REAR CAP SCREW
53	J32-0401	OSCILLATING GEAR
54	G46-7105	OSCILLATING GEAR BALL BEARING
55	H27-2201	OSCILLATING GEAR SCREW
56	H24-3301	STOPPER COLLAR
57	H24-3201	STOPPER
58	351-6401	STOPPER SCREW
59	J30-8601	STOPPER SPRING
60	J32-1201	DRIVE GEAR O-RING
62	371-2824	DRIVE GEAR BALL BEARING WASHER
63	G52-2802	DRIVE BALL BEARING (A)

Key No	Part No	Description
64	J79-3701	BODY COVER
65	J42-3501	BODY COVER SCREW WASHER
66	351-6417	BODY COVER SCREW(A)
68	H04-7201	DRIVE BEARING RING
69	F40-9001	HANDLE COLLAR
70	160-8101	HANDLE WASHER
71	J31-1602	HANDLE SCREW
72	J79-3901	HANDLE ASSY
73	G57-8501	PINION BEARING SPRING WASHER (B)
74	H38-0901	DRAG DISC WASHER(B)
200	H51-3201	HANDLE KNOB WASHER(A)
201	B41-1703	HANDLE KNOB WASHER(B)
202	H85-0401	HANDLE KNOB COLLAR
203	H74-4901	HANDLE KNOB ASSY
204	B67-9308	HANDLE KNOB SCREW
205	H47-6301	HANDLE KNOB CAP

### ELT5000 Special Parts

Key No	Part No	Description
6	J79-4201	SPOOL ASSY ( 2-5 )

### ELT6500 Special Parts

Key No	Part No	Description
3	F75-5504	DRAG WASHER
6	J79-4901	SPOOL ASSY ( 2-5 )
9	H32-3701	CLICK HOLDER
10	G34-1401	CLICK REAF SPRING
13	J31-0601	ROTOR COVER
14	J31-0501	ROTOR NUT
15	J31-6501	ROTOR NUT PLATE
16	J30-9401	ROTOR
17	H78-2801	ROTOR BRAKE SPRING
18	E27-2501	ROTOR BRAKE WASHER
19	H68-4601	ROTOR BRAKE SHAFT
20	H68-4701	ARM LEVER SPRING COLLAR
21	G41-8101	ARM LEVER SPRING
22	J30-9601	ARM LEVER SHAFT WASHER
23	J30-9501	ARM LEVER SHAFT
27	J30-9803	ARM LEVER SPRING COVER
29	J30-9901	BAIL ASSY
36	J30-9201	ONEWAY CLUTCH PLATE
42	H24-3901	PINION BEARING WASHER (A)
44	E33-9701	RATCHET WASHER
45+61	202-4229	PINION GEAR + DRIVE GEAR UNIT
46	B86-1704	PINION BALL BEARING (B)
47	J30-8101	PINION BALL BEARING (B) COLLAR
48	J79-4401	BDY ASSY
49	J30-7701	MAIN SHAFT
50	J30-8001	OSCILLATING POST (A)
51	J30-8904	REAR CAP
53	J30-7601	OSCILLATING GEAR
55	H34-7101	OSCILLATING GEAR SCREW
57	H33-9401	STOPPER
60	J30-8501	DRIVE GEAR O-RING
64	J79-4701	BODY COVER
72	J79-4801	HANDLE ASSY

### ELT8000 Special Parts

Key No	Part No	Description
6	J81-6301	SPOOL ASSY ( 2-5 )